



# Detailed Design Package

Module 2B Product Lifecycle Management Tools

# Motivation

*Why is this module important?*



- The goal of product lifecycle management (PLM) is to eliminate waste and improve efficiency
- PLM tools ensure that your design documents are up to date and properly organized allowing efficient iteration with contract manufacturers and quality maintenance
- Use PLM tools to help design the product you intend

## **PLM tools:**

- Create a BOM
- Organize and number documents
- Track and authorize design changes

*As soon as feasible, companies should adopt a formal PLM system*

# Module Outline



- Learning objectives
- Managing design documents
- Understanding bill of materials (BOM) in a product lifecycle management (PLM) system
- Engineering change management and approval
- Computer-aided design (CAD)
- Additional resources

# Learning Objectives



- LO1: Understand the role of a PLM system
- LO2: Organize processes necessary to make design changes

# What This Module Addresses



- The importance of PLM tools for tracking design documents and changes
- How you can track the BOM and design documents with PLM software and using conventional office tools
- Important design rules for ensuring that designs are clearly understood and altered

# Product Lifecycle Management

*Where does this fit into the development cycle?*

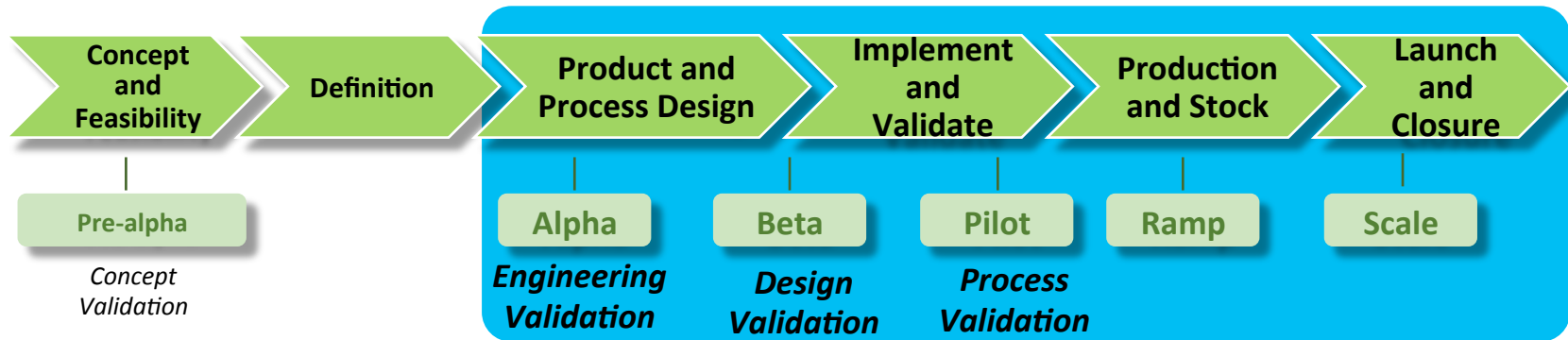

- ❑ PLM tools are used throughout the later stages of the product-design process
- ❑ Once design documents are entered into the PLM system, the system tracks changes and other aspects
- ❑ Design documents relate directly to the BOM and BOP (Module 2A)

# Product Lifecycle Management

*Where does this fit into the development cycle?*

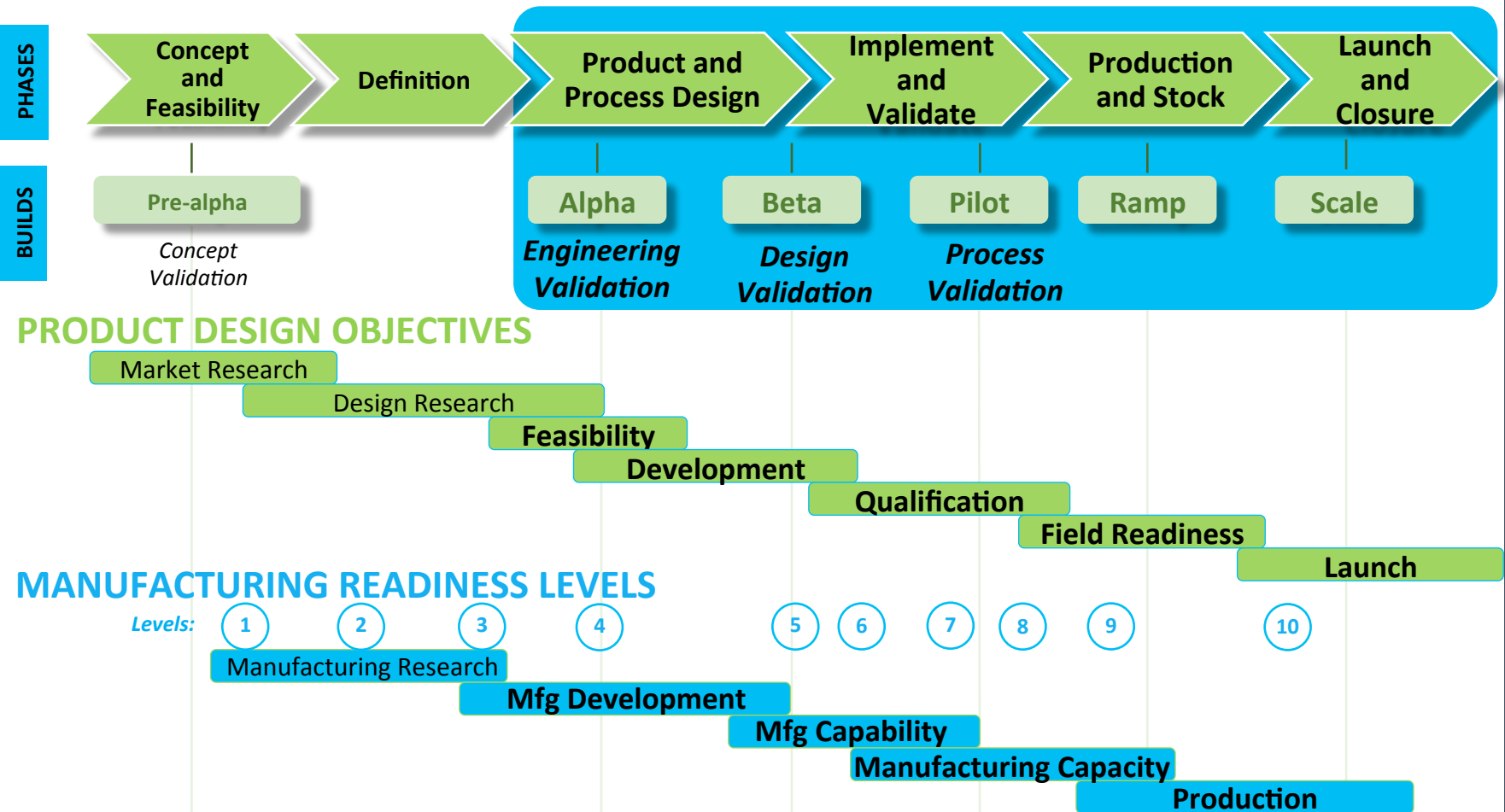

Product Lifecycle Management Tools

U.S. DEPARTMENT OF ENERGY • OFFICE OF ENERGY EFFICIENCY & RENEWABLE ENERGY

# Design Documents

## *Computer-aided design*



**A product has various design documents associated with it:**

- Computer-aided design (CAD) component models describe the constituent parts of an assembly
- CAD assembly models:
  - Assembly models can contain component or subassembly models
  - The BOM can be integrated into the CAD assembly drawing
- CAD files associated with purchased components; often included for assembly purposes



# PLM Tools

## *Basics*



- These file-storage systems contain design documents, and should control access and changes to documents

### **A PLM tool should track:**

- Part numbers
- Design stages
- BOM
- Part changes (e.g., increased section thickness)
- Approvals
- Suppliers and vendors

*Ideally, all members of the project team are kept informed during the design process*

# PLM Tool Options



- PLM software can be used to automate the management of product-related data and integrate the data with other business processes such as enterprise resource planning (ERP) and manufacturing execution systems (MES)
- Some aspects of PLM can be handled with spreadsheets, email, and a networked drive, depending on the size and scale of the enterprise and product

**There are numerous PLM software options, including:**

- Autodesk Vault
- Siemens Teamcenter
- PTC Windchill
- Dassault ENOVIA

# PLM Tools

*When do you need them?*



**As your firm grows, and complexity increases, you may need to upgrade to a formal PLM system, based on:**

- Number of people in your firm
- Number of distinct products
- Number of reused or common components
- Versions of design documents
- Number of people who need to approve changes

# Design Documents

## Spreadsheets versus PLM software



- Documents are assigned a number

Excel  
Spreadsheet

Part Number	Created By	Part type	Design documents
Manually created part number	Person creating	Select from custom drop-down menu	Path of design document

PLM  
Software

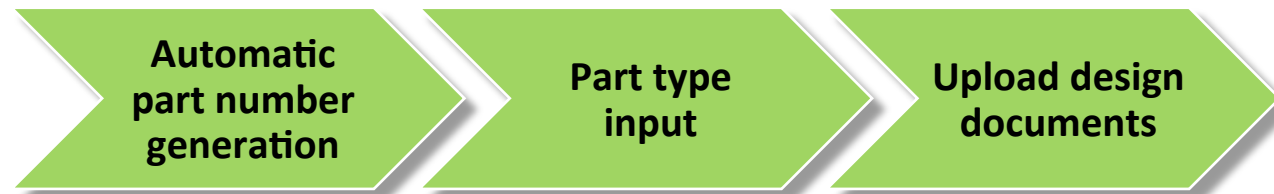

# Bill Of Materials

## *Basics*



**The bill of materials (BOM) is a detailed list of all product components, including:**

- Parts and subassemblies
- Purchased components and manufactured components
- Information about the attributes of each component (i.e., material)

*See Module 2B for more detail on BOMs*

- Every part and assembly is associated with the BOM; the BOM helps in planning and keeping track of the parts required
- The BOM can also track regional or other product variations; for example, alternative power supplies for different regions

# Bill Of Materials

*Example – BOM on an engineering drawing*



ITEM NO.	PART NUMBER	PART NAME	DESCRIPTION	SOURCE	QTY.
1	UCP21-AST	PILLOW BLOCK BEARING	AST - METRIC SERIES	PURCHASED	1
2	3GAA103001-BSE	ELECTRIC MOTOR 1.5KW	ABB - M2AA100L 6	PURCHASED	1
3	7493251	BASE FRAME	MACHINED	FABRICATED	1
4	7493250	BEARING MOUNTING PAD	MACHINED	FABRICATED	1
5	91292A241	SOCKET HEAD SCREWS	MCMASTER-CARR	PURCHASED	2
6	7493252	MOTOR SHAFT	HARDENED STEEL MACHINED	PURCHASED	1
7	91292A274	SOCKET HEAD SCREWS	MCMASTER-CARR	PURCHASED	4
8	7493254	MOTOR MOUNTING PAD	MACHINED	FABRICATED	1

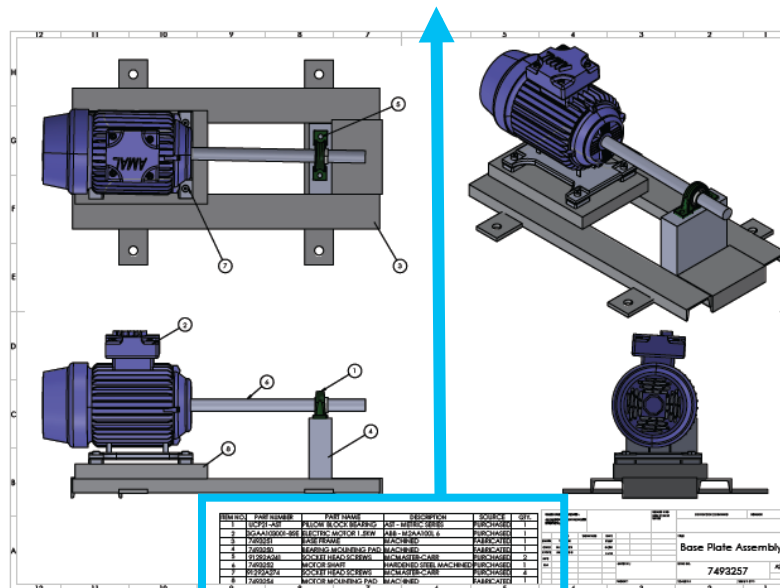

# BOM And PLM



- BOM generation is one of the key benefits of using PLM software as the BOM needs to be maintained and updated when parts are updated
- BOM generation can be done manually (i.e., spreadsheet), but the hierarchy of components can be difficult to track
  - Spreadsheet BOMs become very difficult when there are multiple versions and numerous stock keeping units (SKUs)

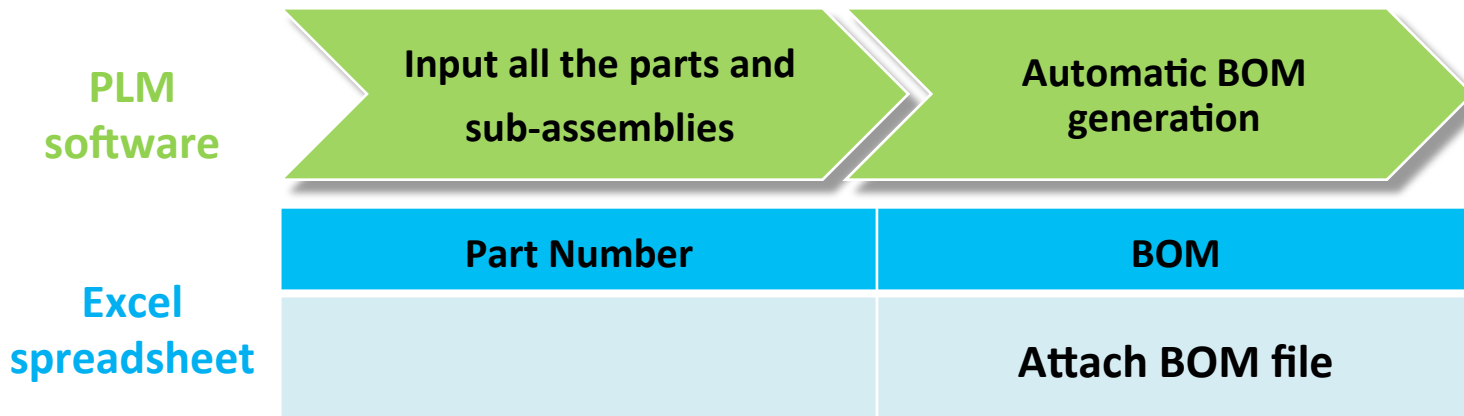

# Component Changes In The PLM

*What they are and when to use them*



**Any minor change in a part/component can have significant implications because:**

- Components are part of assembly models (things may or may not still fit)
- Components may be used across multiple products
- Changes may have manufacturing process implications
- An engineering change order (ECO) process is necessary to ensure that every change is accounted for
  - Typically involves component “check out”
  - Component is then changed and “checked in”
  - “Check in” initiates requests for approval



# Component Changes In The PLM

*What they are and when to use them (cont.)*



- The ECO process ensures that all stakeholders (i.e., product designer, contract manufacturer) are aware of and approve the change(s)
- The first request for approval is for the “release” of the part
- Stakeholders need to approve the final version of the component

# Engineering Change Order

*Inputs - What to include on an ECO form*



- What is being changed
- Who is making the change
- Reason for the change
- Description of the change
- What components/assemblies are affected by the change
- Who needs to approve the change
- When this change will go into effect
- What will be done with existing parts that are no longer of use
- Any necessary testing approvals, certifications, or sign-offs
- Impact on production/purchase costs

# Change Management In PLM

*Key to the design process*



- Components and assemblies need to be tracked and revisions approved by all stakeholders
- When changes are going to be made to a component, it should be “checked out” so other users know the component is being revised
- Once the changes have been made, it can be “checked in” for approval and release
- Released parts may be in the process of being manufactured; decide if existing inventory will be used, scrapped, etc.

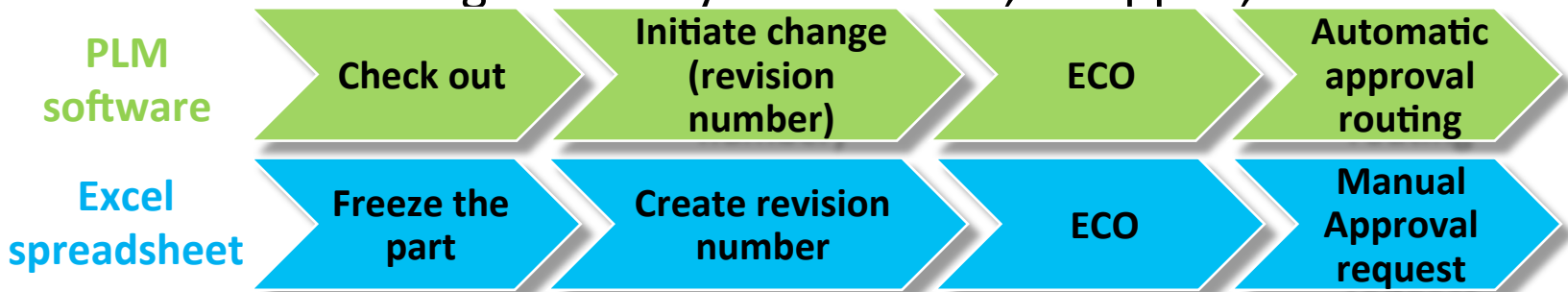

Product Lifecycle Management Tools

U.S. DEPARTMENT OF ENERGY • OFFICE OF ENERGY EFFICIENCY & RENEWABLE ENERGY

# Complete PLM Flowchart

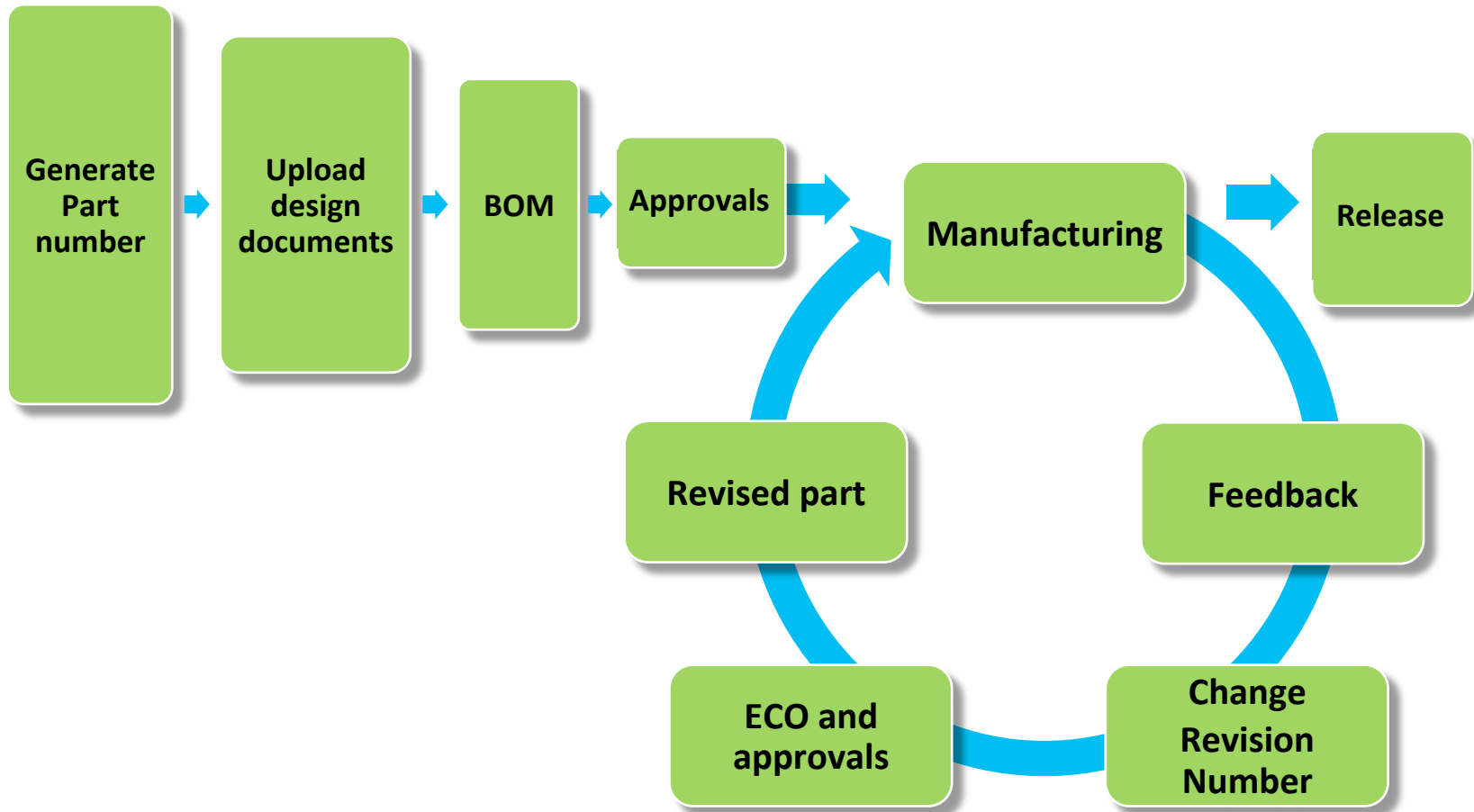

# Computer-Aided Design Tools

## *Basics*



### Modern CAD tools are:

- ❑ **Feature-based:** Simple design features (i.e., extrusions or cuts) are used to create complex geometry
- ❑ **Parametric:** The aspects of a feature are controlled by parameters (i.e., width, depth)
- ❑ **Solid modeling:** The CAD model contains a significant amount of information that would be available from an actual component (mass, center of gravity, etc., can be gleaned from the CAD model)
- ❑ Product complexities highlight the need for clear design data  
—Complex CAD models can contain hundreds or thousands of features and components

# CAD And Design Intent



- Design intent is the rationale for why certain feature selection and constraint decisions were made
- Design intent should inform how a model will be when it is altered
- Key design considerations should inform design intent

*Example:* One hole is fixed, one is driven by an equation, and the other two are mirrored. As the size of the hinge changes, the holes remain properly spaced along the length and width.

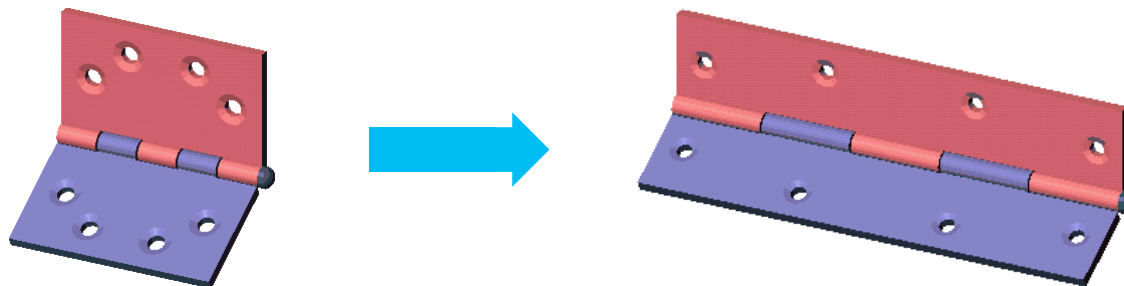

# CAD And Design Intent

*(cont.)*



## **Parametric modeling tools have model trees:**

- Model trees show the hierarchical relationship among features
- Understanding these relationships is critical when making component alterations
- Design intent is also critical in assemblies and the relationships among components

# Product Lifecycle Management

## *Key considerations*



### **Cost:**

- ❑ PLM systems can be very costly; however, their benefits for BOM and product management are significant
- ❑ As soon as feasible, companies should adopt a formal PLM system

### **Quality:**

- ❑ Design decisions drive quality; these decisions are implemented through design documents
- ❑ Design documents must be tracked and properly managed to maintain quality



# Product Lifecycle Management

*Key considerations (cont.)*



## Iterations:

- All iterations of the design should be traceable throughout the design documents
- The ECO process ensures that all stakeholders are aware of and approve any changes

## Risk:

- Tracking design changes and using a documented ECO process reduces risks
- A change implemented on one product may be detrimental to another product that uses the same component

# Resources



- Resilient modeling

<https://community.plm.automation.siemens.com/siemensplm/attachments/siemensplm/solid-edge-tkb/159/>

- The model-based enterprise

<https://www.nist.gov/publications/model-based-enterprise-manufacturing>